

# **Re-Construction of Palaeo-Sedimentation Processes of Aquifers underlying Igueben using Geo-Electrical Resistivity Signature and Borehole Data**

**S. O. Salufu<sup>a</sup> and I. Aigbedion<sup>a\*</sup>**

<sup>a</sup> *Department of Geophysics/Physics, Ambrose Alli University, Ekpoma, Nigeria.*

## **Authors' contributions**

*This work was carried out in collaboration between both authors. Both authors read and approved the final manuscript.*

## **Article Information**

DOI: 10.9734/AJGR/2021/v4i4104

### Editor(s):

(1) Dr. Hani Rezgallah Al-Hamed Al-Amoush, Al al-Bayt University, Jordan.

### Reviewers:

(1) Safaa Fakhir Yasir, Malaysia.

(2) Işın Onur, Akdeniz University, Turkey.

Complete Peer review History, details of the editor(s), Reviewers and additional Reviewers are available here:

<https://www.sdiarticle5.com/review-history/78148>

**Received 25 October 2021**

**Accepted 20 December 2021**

**Published 22 December 2021**

**Original Research Article**

## **ABSTRACT**

Igueben is located in the central of Edo State, Nigeria. It has neighboring towns; Ogwa, Ugbegun, Ugiogba, Ebelle, and Ekpon. These towns have the same aquifer but significant variations in the water table. However this study is intended to unravel the salient ancient hydrological processes that occurred in the study area which resulted in this variation. Vertical electrical sounding (VES) data and borehole data of the area are integrated to generate geo-electrical resistivity section of the area, to identify the aquifer trends, body, and shape to re-construct the palaeo-sedimentation processes of the aquifers that underlie Iguebe and the neighboring towns. The inversion model result for the seven VES conducted in the study area show that the curve types are HQA, AHA, A, AHA, AHA, HAQ, and AQA, respectively. These curve type suggested that the aquifer type is anarenite sandstone aquifer that has been transported from a long distance. The geo-electrical pattern and shape show that Igueben and Ogwa (shallow marine) are the points of deposition from where other nearby towns (Ugbegun, Ugiogba, Ebelle, and Ekpon) sourced their aquifer by gravity settling from suspended sediments in water body into adjacent deep marine environment (Ugbegun, Ugiogba, Ebelle, and Ekpon). The study showed that Igueben and Ogwa are the hydraulic-head of the aquifer in the study area. The geological processes that had occurred in the study area during sedimentation are responsible for the variation in the water table in the study area.

\*Corresponding author: E-mail: isaacaigbedion@yahoo.com;

*Keywords: Igueben; aquifer; palaeo-sedimentation processes; geo-electrical resistivity.*

## 1. INTRODUCTION

Palaeo-sedimentation processes of an aquifer are all the processes that had taken place in the past as at the time of transportation and deposition of an aquifer in a basin [1-2]. These processes are controlled by sediment source availability, agents of weathering, transport media (glacier, wind, and water), proximity of source to basin, bio-chemical activities [3-4]. Mechanical activities, and change in sea level [5-6]. Palaeo-environment where these processes occurred determines the yield of an aquifer. These processes determine the character of an aquifer [7-8]. Hence the knowledge about the palaeo-sedimentation of an aquifer is a clue to the aquifer characteristics. However, aquifer formed by these processes can be altered by geological processes such as erosion and tectonic activities.

Little/scanty literatures about the hydrogeology and geology of Igueben exist. However, borehole data of the wells in the area was provided by Rock Well Drilling Company as acquired in 2018. Igueben has been known to have groundwater occurrence at both shallow depths (120-140m) and deep depths (220m and above) while Ugiogba, Ugbegun, Ebelle, and Ekpon that are neighboring towns have deep aquifers. However, no existing literature have been able to explain the reason for such occurrence. Borehole data from these towns have shown that the aquifer comprises the same derived properties such as fine grained sandstone facies. Existing literatures have not been able to give reason(s) for the variation in the water table among the Oligocene age aquifers that exist in Igueben. This present study is intended at unraveling the reason and the salient hydrological processes that occur in the study area by re-constructing the Palaeo-sedimentation processes of the aquifers that underlie Iguebe and the neighboring towns using geo-electrical section according to Koefoed [9] and borehole data of the areas to characterize the aquifers according to the aquifer's sandstone type [10] aquifer deposition environment, and hydraulic head.

## 2. SITE DESCRIPTION AND LOCAL GEOLOGY

The study area is located in the part of Esan Central in Edo State. The area is part of the

Lower Benue Trough (Anambra Basin) arm that extends to Edo State [11]. The basin was evolved after the Santonian Tectonic event that occurred in the Southern Nigerian [11]. It comprises Iguebe, Ugiogba, Ugbegun, Ogwa, Ebelle, and Ekpon (Fig. 1) in Iguebe Local Government Area of Edo State, Nigeria. The area is accessible by major road, Uromi-Agbor Road, and other minor roads (Fig. 1).

The area is underlain by clayey sandstone and lateritic sandstone facies that belong to Ogwashi-Asaba Formation. The formation has a general strike of 89°NE-269°SW, dip direction is towards 178° SE, and dip is 5°. This shows that the basin is tectonically stable, no history of tectonic activities. The lateritic sandstone facies covers Ugbegun, Ugiogba, Ogwa, Igueben, and Ebelle while Ekpon is covered by clayey sandstone facies (Fig. 2). The sandstones have general dip direction of south east direction with 5° dip (Fig. 2). The sandstones are reddish to brown and friable.

## 3. MATERIALS AND METHODS

### 3.1 Data Acquisition

Seven Vertical Electrical Sounding (VES) were conducted in Igueben and neighboring towns (Fig. 3) using Schlumberger array (Fig. 4) to determine the depth of water table and depth of aquifer occurrence in each town. Borehole data of four wells in the study area were obtained from Rock Well Drilling Company. The result of seven VES obtained in the area was integrated with the borehole data to generate geo-electrical resistivity section of the area. The motive of the geo-electrical section of the study area was used to characterize the aquifer and infer the palaeo-sedimentation processes that had taken place in the course of aquifer deposition in the area. Thus salient information useful to the modeling of the hydrogeological setting of the area was deduced.

As the fluid flow into the basin or from one part of the basin to another part in the time past, the fluid carried sediments along and got deposited into the basin as fluid mass. The fluid masses either gained or lose velocity by moving into an area where the velocity had changed in time at any position. The deposited sediments can be aquifer, aquitard or aquiclude. The total fluid

acceleration during sedimentation in a basin is given as  $\frac{Du}{Dt}$ .

where,  
Capital D = total differential coordinate  
s = natural coordinate  
Hence,

$$\frac{Du}{Dt} = \frac{\partial u}{\partial t} + \left(\frac{\partial u}{\partial s}\right) \quad (1)$$

Expanding into 3D coordinate equation (2) becomes:

$$\frac{Du}{Dt} = \frac{\partial u}{\partial t} + (u\frac{\partial u}{\partial x} + v\frac{\partial u}{\partial y} + w\frac{\partial u}{\partial z}) \quad (2)$$

Thus, equation (2) can be transformed to:

$$\frac{Du}{Dt} = \frac{\partial u}{\partial t} + u \cdot \nabla u \quad (3)$$

Aquifer that is deposited in a basin can be located by VES using the basic principle of ohm's law:

$$R = \frac{V}{I} \quad (4)$$

Resistivity in equation (4) is the measured resistivity by Terrameter. The true resistivity of the subsurface is gotten by multiplying equation

(4) with geoelectric factor (K) to have apparent resistivity ( $\rho_a$ ).

$$\rho_a = K \frac{V}{I} \quad (5)$$

K is computed using the general equation (6)

Let the separations of current and potential electrodes in Fig. 4be L and a, respectively. General equation is given as:

$$\rho_a = 2\pi \frac{V}{I} \left[ \frac{1}{\left(\frac{1}{A} - \frac{1}{B}\right) - \left(\frac{1}{C} - \frac{1}{D}\right)} \right] \quad (6)$$

Then

$$A = D = \frac{(L-2)}{2} \quad (7)$$

$$C = B = \frac{(L-2)}{2} \quad (8)$$

Substituting in equation (6)

$$\rho_a = 2\pi \frac{V}{I} \left[ \frac{1}{\left(\frac{2}{L-a} - \frac{2}{L+a}\right) - \left(\frac{2}{L+a} - \frac{2}{L-a}\right)} \right] \quad (9)$$

Hence, equation (9) becomes:

$$\rho_a = \frac{\pi V}{4 I} \left( \frac{L^2 - a^2}{a} \right) \quad (10)$$

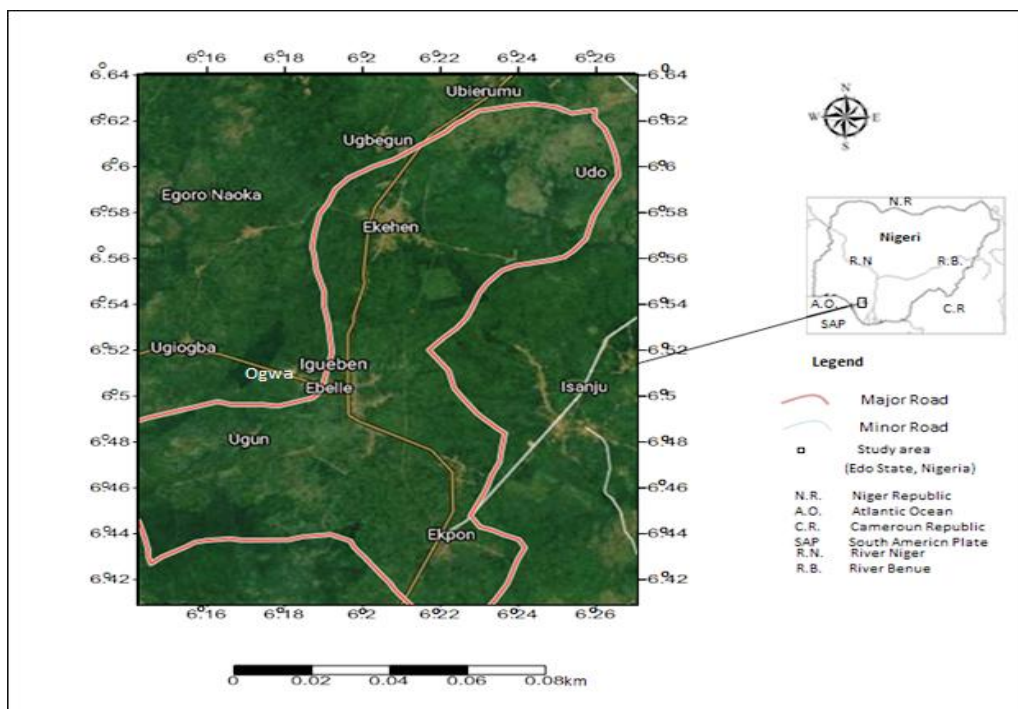

Fig. 1. Location and accessibility map of the study area showing Igueben and neighbouring towns

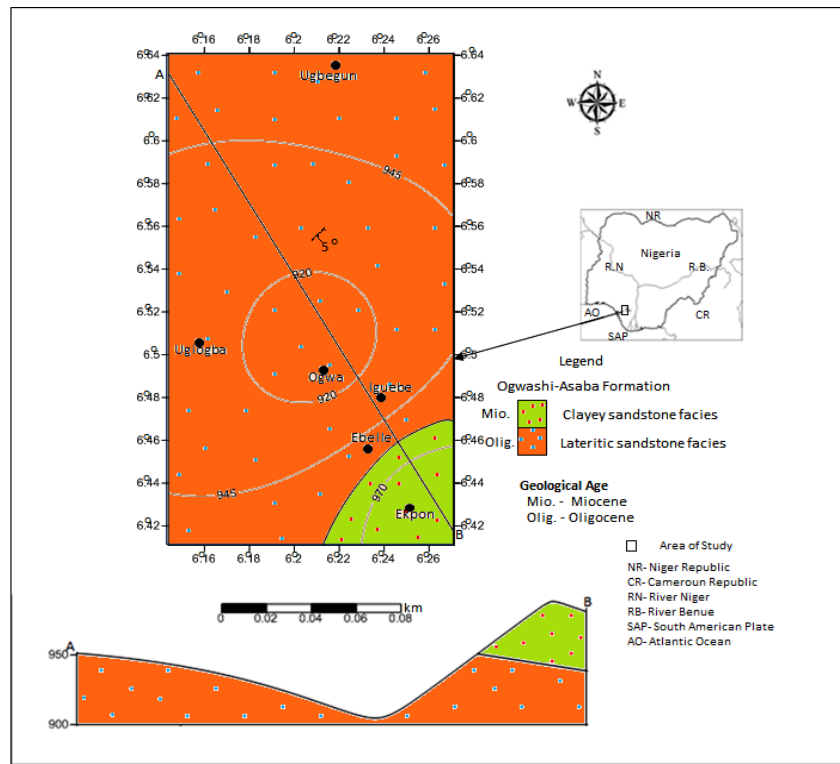

Fig. 2. Geological map of the study area

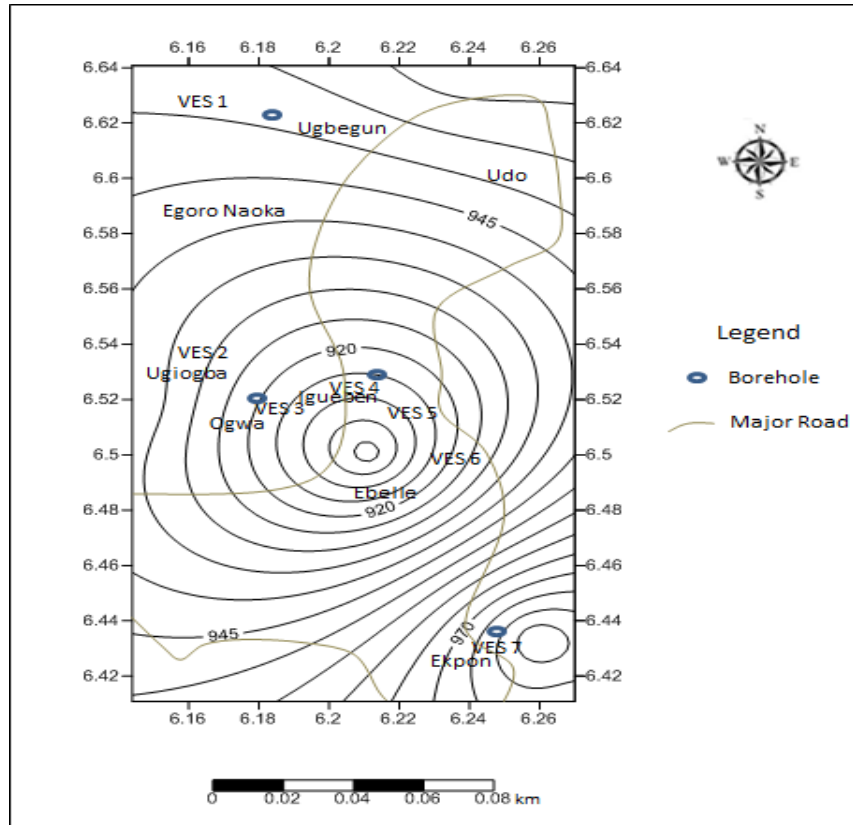

Fig. 3. Map of the study area showing the VES points and borehole locations

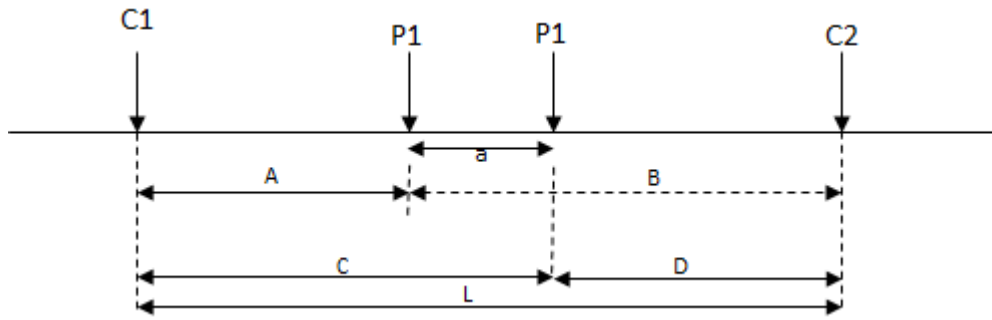

Fig. 4. Schlumberger array After Lowrie, [13]

### 3.2 Inversion Model

Subsequently, Res1Dinvers is used to carry out the inversion model to produce a model response that matches the measured values by using the least-squares optimization method after

Lines and Treitel (1984) according to equation (11) as shown below:

$$(J^T J + \lambda I) \Delta_{q_k} = J^T g \quad (11)$$

The purpose of the inversion subroutine was to determine the resistivity and the thickness of the aquifer in the study area and to determine depth to water table and the geology of the area.

Q= the model parameter vector that consists of the logarithm of the resistivity and thickness of the layers.

g = the discrepancy vector that consists of the difference between the logarithms of the calculated and measured apparent resistivity values.

$\Delta q$ = the model parameter change vector, and J=the Jacobian matrix of partial derivatives.

The elements of the Jacobian matrix are expressed in equation (12)

$$J_{ij} = \frac{\partial f_i}{\partial q_j} \quad (12)$$

It is the change in the  $i$ th model response  $f_i$  due to a change in the  $j$ th model parameter  $q_j$ . I is the identity matrix. The factor  $\lambda$  is known as the Marquardt or damping factor, and this method is also known as the ridge regression method [12]. The damping factor effectively constrains the range of values that the components of parameter change vector can  $\Delta q$  take. The damped least-squares method attempts to minimize a combination of the magnitude of the

discrepancy vector and the parameter change vector.

### 4. RESULTS AND DISCUSSION

The result of raw field resistivity data acquired in the study area is given in Table 1. The inversion model is given in Fig. 5 and Fig. 6. The inversion model for the seven VES conducted in the study area showed that the curve types for the seven VES are HQA, AHA, A, AHA, AHA, HAQ, and AQA, respectively. The pattern of the curve type showed that the aquifers are arenit sandstone that had undergone second cycle, sedimentsrecycled probably from a long distance. The resistivity results for the seven VES acquired in the study area showed that Ogwa and Iguebe have the shallowest water table 110m and 120, respectively. However, Iguebe result indicated that Iguebe has two distinct water table; shallow and deep; 120m and 220m, respectively. The shallow water table is restricted to the northern part of Iguebe while the deep water table occurs in the southern part. Ugiogba, Ugbegun, Ebelle, and Ekpon, have deep water table; 240m, 250m, 230m, and 240m, respectively [14-16].

### 5. RE-CONSTRUCTION OF PALAEO-SEDIMENTATION PROCESSES OF IGUEBE AND ENVIRONS

The integration of resistivity section and the borehole data in the study area obviously revealed the fact that the aquifer deposits depth was shallow at Iguebe north and Ogwa, thus became deepening towards the south and extreme north of the study area in Iguebe south, Ugbegun, Ugiogba, Ebelle, and Ekpon. They are located as shown in the geo-electrical resistivity section of the study area (Fig. 7). The borehole data (Fig. 8) in the study area confirmed this

fact. The pattern of the geo-electrical section showed that Ogwa and Iguebe north represented the point in the ancient sea where river flowed into the standing body of water (sea). The geo-electric pattern suggests that Ogwa and Igueben are the hydraulic-head of the aquifer in the study area. The sediment

continued to get deposited at the mouth of the standing sea and subsequently got distributed to deeper part (Ugiogba, Ugbegun, Iguebe south, Ebelle, and Ekpon) of the ancient sea by the flow of the river into the sea, in response to the gravity.

**Table 1. Raw field VES data acquired in the study area**

S/N	AB/2	MN/2	Ugbegun (Ωm)	Ugiogba (Ωm)	Ogwa (Ωm)	Igueben North(Ωm)	IguebeSouth (Ωm)	Ebelle (Ωm)	Ekpon (Ωm)
1	5	2	1493	726	1493	1593	786	616.14	770
2	15	2	1559	887	1359	1659	987	826.9	1571
3	20	2	2117	1174	2217	2217	1274	918.6	2134
4	40	5	2178	1520	2378	2678	1620	1027	3145
5	80	5	3156	1493	3456	3456	1593	2091	4156
6	120	10	2267	1559	4767	4567	1659	3189	6473
7	140	10	2267	2117	4867	4667	2217	3563	7895
8	180	10	2589	2478	4989	4789	2678	3465	9312
9	220	15	4498	4356	4898	4798	3456	3387	13459
10	360	15	4821	4567	4701	4801	4567	3667	15678

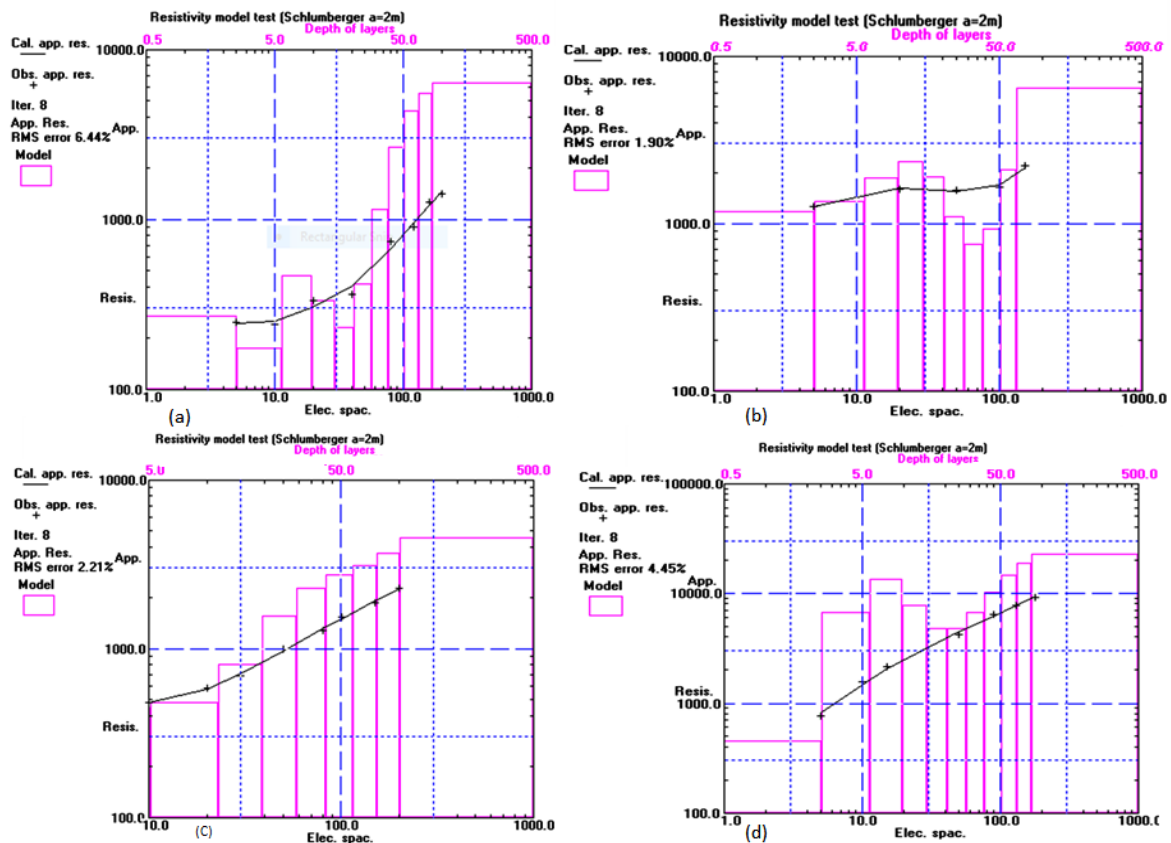

**Fig. 5. (a) Inverted model layer for VES 1 taken at Ugbegun (b) Inverted model layer for VES 2 taken at Ugiogba (c) Inverted model layer for VES 3 taken at Ogwa (d) Inverted model layer for VES 4 taken at Iguebe north in Edo State**

The grain size of very fine grained sandstone and siltstone sequence (Fig. 8) that majorly the character of the aquifers in the study area corroborated the fact that the sandstone were transported from very far distance into the basin (sea) later moved from the mouth of the sea (shallow part) to other deeper parts as suspended load within the water body (sea). The motive of the geo-electrical section and litho-log of boreholes section indicates Ogwa and Iguebe

north to be the hydraulic head (HH) of the entire aquifers in the study area (Fig. 8). This is due to the manner the palaeo sedimentation processes occurred in the area. Thus groundwater moved from the Ogwa and Igueben north radially to other aquifers around them. Hence the aquifer that underlies the study area was deposited in a transitional (tidal flat) between marine and fluvial where wave energy washed silt and clay away, leaving sandstone particles behind.

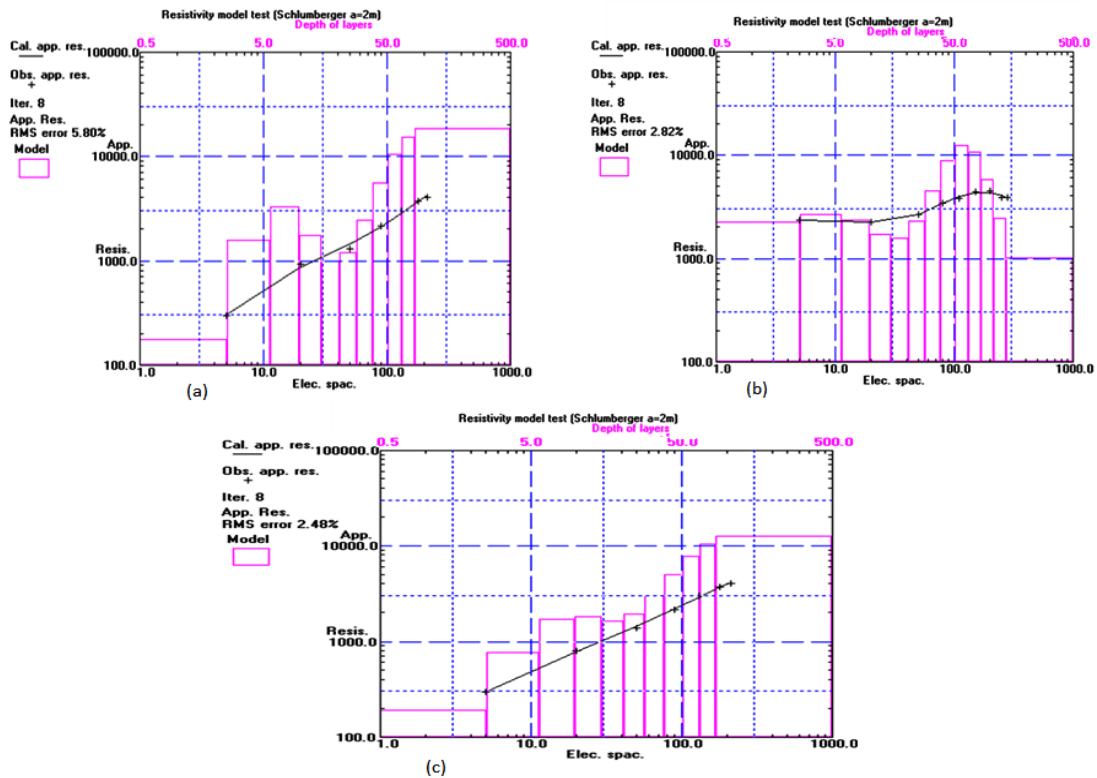

Fig. 6. (a) Inverted model layer for VES 5 taken at Iguebe south (2) Inverted model layer for VES 6 taken at Ebelle (c) Inverted model layer for VES 7 taken at Ekpon in Edo State

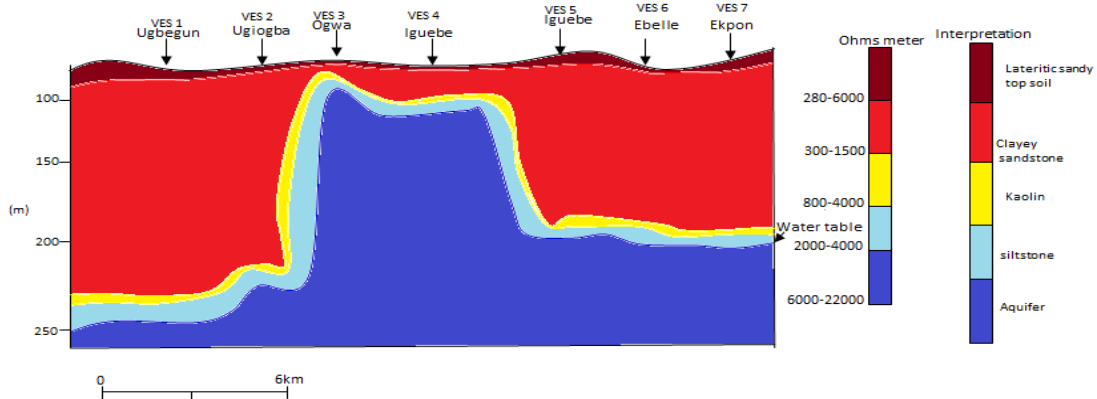
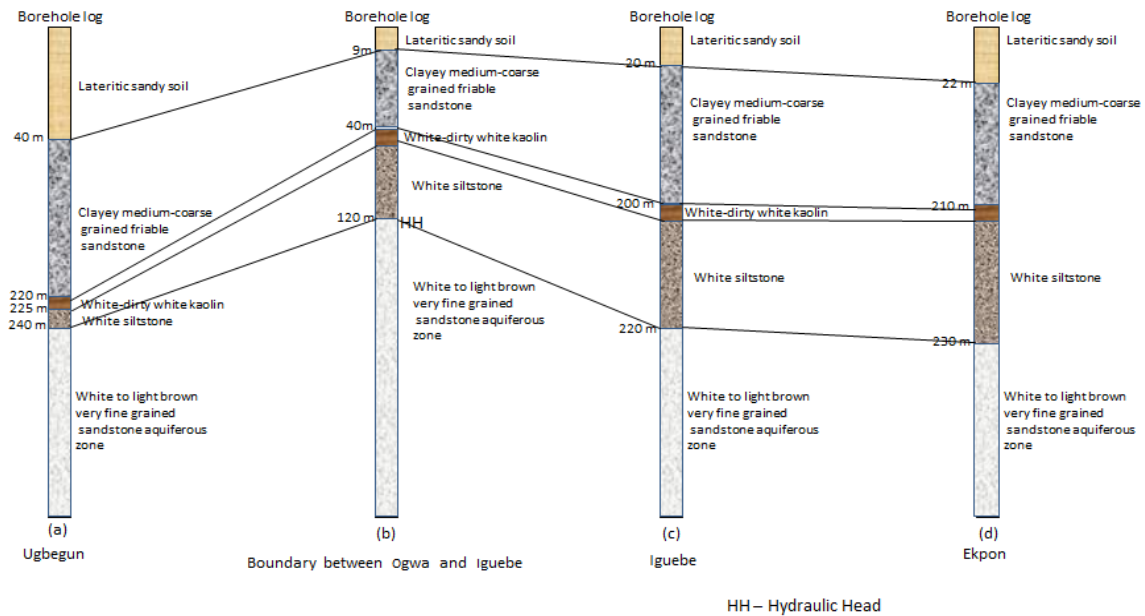

Fig. 7. Geo-electrical resistivity section of the study area



**Fig. 8. Litho-log of boreholes section of the study area (Source of borehole data: Rock Well Drilling Company)**

## 6. CONCLUSION

Palaeo-sedimentation processes of Iguebe and environs have been successfully carried out using integrated data of vertical electrical resistivity and borehole in the area. The data was used to generate geo-electrical resistivity section of the aquifers that underlay the area in order to re-construct the aquifers trends and body. Subsequently, the ancient geological processes that led to the deposition of the aquifers and the palaeo-environment of the aquifer was delineated using the geo-electric section and the borehole data. The study has shown that Iguebe north and Ogwa are the depo-center where wave energy from marine environment washed the transported sandstone from far source and distributed it to deeper parts (Iguebe south, Ugbegun, Ugiogba, Ebelle, and Ekpon) of the marine by suspension of particles that settled down due to gravity effect. Thus, the aquifers were deposited at different marine environments during Oligocene. This was responsible for the variations in the water table across the study area.

## COMPETING INTERESTS

Authors have declared that no competing interests exist.

## REFERENCES

1. Arua I. Palaeo-environment of Eocen Deposits in Afikpo Syncline, Southern Nigeria. *Journal of African Sciences*. 1986;5:297-284.
2. Arua I, Okoro AO. Reconstruction of Palaeo-wave and paleao-depth Regimes of Nkporo Sea (Campano-Maastrichtian) Using Wave formed Ripple Marks. *Journal of Mining and Geology*. 1989;25(1/2):75-79.
3. Stow DAV, Huc AY, Bertrand P. Depositional processes of black shales in deep water: Marine and Petroleum Geology. 2001;18:491-498.
4. Ver Straeten CA, Brett CE, Sageman BB. Mudrock sequence stratigraphy: A multi-proxy (sedimentological, paleobiological and geochemical) approach, Devonian Appalachian Basin: Palaeogeography, Palaeoclimatology, Palaeoecology. 2011; 304:54-73.
5. Brett CE, Baird GC, Bartholomew AJ, Desantis MK, ver Straeten CA. Sequence stratigraphy and a revised sea-level curve for the Middle Devonian of eastern North America: Palaeogeography, Palaeoclimatology, Palaeoecology. 2011; 304:21-53.
6. Ryan DW, Juergen S. Sedimentary Facies and Depositional Environment of the



- Middle Devonian Formation of New York, USA. *Journal of Sedimentary Research*. 2015;85:1393-1415
7. Woodrow DL. Paleogeography, paleoclimate, and sedimentary processes of the Late Devonian Catskill Delta, in Woodrow, DL, Sevon WD. eds., *The Catskill Delta: Geological Society of America, Special Paper*. 1985;201:51–63.
  8. Gary N. *Sedimentology and Stratigraphy* Second Edition Willey Black publisher; 2009.
  9. Koefoed O. *Geosounding Principles 1: Resistivity sounding measurements*. Elsevier Science Publishing Company, Amsterdam; 1979.
  10. Aigbedion I, Salufu S. Impact of Sandstone Maturity on Groundwater Resistivity in Geophysical Groundwater Exploration in Parts of Edo Central and Agbor, Delta State, Nigeria. *South Asian Research Journal of Natural Products*. 2021;4(2):1-10 Article no.SARJNP.66284
  11. Benkhelil J. The Evolution of the Cretaceous Benue Trough, Nigeria. *Journal of African Earth Sciences*. 1989; 8:251-282.
  12. Inman JR. Resistivity inversion with ridge regression. *Geophysics*. 1975;40:798-817.
  13. Lowrie W. *Fundamentals of Geophysics*. Institute of Geophysics, Swiss Federal Institute of Technology. Zurich, Switzerland. Cambridge University Press. 1997;354.
  14. John Wiley & Sons Ltd, The Atrium, Southern Gate, Chichester, West Sussex, PO19 8SQ, UK
  15. Lines LR, Treitel S. Tutorial: A review of least-squares inversion and its application to geophysical problems. *Geophysical Prospecting*. 1984;32:159-186.
  16. Rock Well Drilling Company. Unpublished article, Auchi-Edo State-Nigeria; 2018.

© 2021 Salufu and Aigbedion; This is an Open Access article distributed under the terms of the Creative Commons Attribution License (<http://creativecommons.org/licenses/by/4.0>), which permits unrestricted use, distribution, and reproduction in any medium, provided the original work is properly cited.

*Peer-review history:*

*The peer review history for this paper can be accessed here:*

<https://www.sdiarticle5.com/review-history/78148>