



Design and Optimization of a Wind System Using a Genetic Algorithm

Clarence Semassou^{1*}, Gaston Edah² and Antoine Vianou³

¹Laboratory for Energy and Applied Mechanics, Technical University of Abomey, 01 BP 2009 Cotonou, Benin.

²Department of Physics, Faculty of Science and Technology, University of Abomey, Benin.

³Laboratoire de Caractérisation Thermophysique des Matériaux et d'Appropriation Energétique Ecole Polytechnique d'Abomey-Calavi, 01 BP 2009 Cotonou, Benin.

Authors' contributions

This work was carried out in collaboration between all authors. Author CS designed the study, performed the statistical analysis, wrote the protocol, and wrote the first draft of the manuscript. Authors GE and AV managed the analyses of the study. Author GE managed the literature searches. All authors read and approved the final manuscript.

Research Article

Received 1st April 2013
Accepted 6th June 2013
Published 15th June 2013

ABSTRACT

Aims: The aim sought is to design a wind energy system can meet the energy needs of a rural household in minimizing both the economic cost and the energy cost of the system over its life cycle while ensuring continuity in the provision of electrical energy.

Study Design: Design of a wind system study.

Place and Duration of Study: Department of Mechanical Engineering and Energy, Laboratory Energy and Applied Mechanics, between September 2012 and March 2013.

Methodology: We have adopted an approach that requires a combination of field work and scientific work. A survey has been conducted in the locality chosen to know the equipment used to determine the consumption profile; some players were involved in determining the weight we assigned to different criteria. The NSGA-II algorithm, evolutionary genetic type was used in the context of determining the set of optimal solutions of compromise. Design variables used are the wind turbines number, batteries number, wind turbine type, battery type and height of the mast of the wind. The various programs developed have been implemented in Matlab. The method proposed has been applied to a rural household locality of Benin, named Dekin to ensure its power supply.

Results: The design made it possible to generate several candidate solutions that are

*Corresponding author: Email: seclar2001@yahoo.fr;

available to the user. There is also the implementation of solutions and promoting the shedding of solutions providing continuous coverage of consumer needs.

Conclusion: The multi-objective design of a wind system is not an easy task since antagonistic criteria are taken into account. To this end, we found a compromise by assigning different weight goals. Solutions to economic and energy low cost are found while improving the service delivered to the consumer.

Keywords: Optimization; photovoltaic autonomous; genetic algorithm; cost on life cycle; rural environment.

1. INTRODUCTION

Renewable energies account for yet only 2% in the world energy assessment, but their growth is of 30% per year [1]. This growth is the result of several factors: Fossil fuel depletion predictable (especially oil), impact on the greenhouse effect and other pollution (corresponding to externalities), increased taxes resulting externalities and to reduce consumption). In addition, according to industry figures BP Statistical review of world energy 2010 [2], global reserves will be depleted to 2084.

The exhaustion of these resources associated with the climate warming which their exploitation causes, must lead us to consider the development of renewable energies. Among the renewable resources available in Benin, wind technology is the most marginalized while studies have shown that apart from the coastal zone, there are other passages that are conducive to the development of small and medium wind power. These systems also lend themselves well to a decentralized electrification especially for remote and difficult to access areas. Factors that restrict the use of these systems in isolated, not connected to the grid are the intermittency of wind, the consumption profile uncontrollable and difficult to anticipate. There is also the management of project risks and the choice of solutions that enable cover the energy needs at low cost without interruption with limiting the impact on the environment. Several optimization methods have been developed to deal with these types of problems. Ref. [3] has proposed an optimization method to determine the optimal configuration of hybrid PV-wind. This method is based on a genetic algorithm using the concept of the loss power supply probability (LPSP) with a minimum annualized cost of system. Ref. [4] presented work on multi-objective optimization of a hybrid PV / wind / diesel / hydrogen / battery simultaneously minimize the life cycle cost analysis, the CO₂ emissions related to diesel and the loss of power supply probability. In this sense, a multi-objective evolutionary algorithm and genetic algorithm are used to determine the optimal configuration of system components. Ref. [5] apply the Pareto optimal evolutionary algorithm to perform multi-objective optimization of an autonomous PV-wind-diesel coupled to storage batteries minimizing the cost of energy and CO₂ emissions of the life cycle of the system. They developed the hybrid optimization based on Genetic Algorithms (HOGA). Ref. [6] presented a paper on the multi-objective optimization of a hybrid photovoltaic-wind-diesel coupled to storage batteries. A multi-objective evolutionary algorithm has been applied to minimize the life cycle cost of the system and CO₂ emissions related to the use of diesel. This paper develops an optimization method which transforms the multi-objective problem into a mono-objective problem using desirability functions. In this study, we optimize a wind system coupled with batteries. We have proposed an optimization method based on the concept of LPSP with minimization of economic cost and energy cost on the system life cycle. A genetic algorithm is used to generate a set of candidate solutions which will be made available to the

user. Thus, the optimization method (Fig. 1) adopted in this study is the first to analyze the need and develop physical models of the various components and to define the evaluation criteria. Then, we determine the level of satisfaction corresponding to the solutions and finally proceed to the evaluation and classification of solutions based on the criteria.

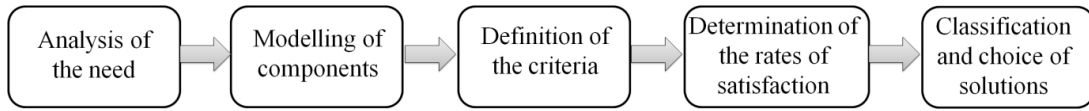

Fig. 1. Synoptic of the method of optimization used

Through a concrete case study, we show that optimal design is used to generate a set of solutions that can help guide the choice of the decision maker.

2. MATERIALS AND METHODS

2.1 Case Study and Wind Data

The proposed method is applied to a wind system designed to meet the energy needs of a rural household. In Fig. 2 are respectively represented the variation of the wind speed over a year.

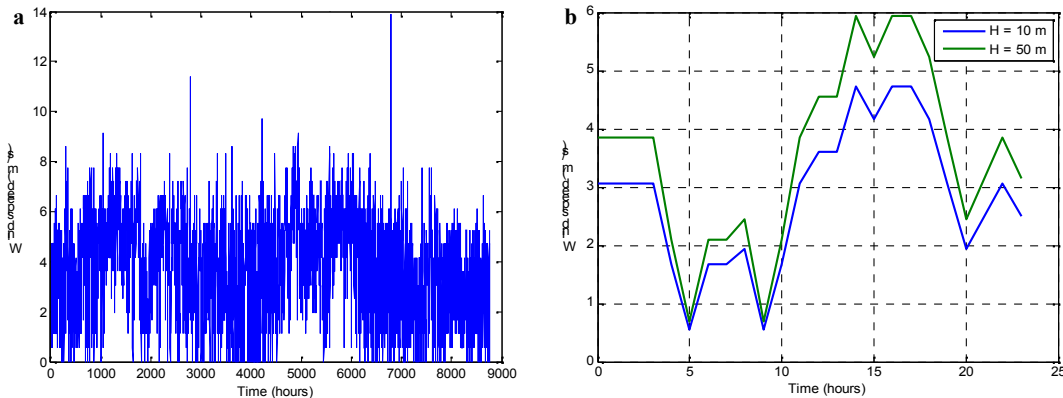

Fig. 2. Variation of wind speed: (a) speed on a year. (b) speed on a day to 10 m and 50 m above the ground

Data on wind speed from the meteorological station in Cotonou, located a kilometer trantaine of the site selected in this work. In addition, these data are measured at 10 m from the ground and made an extrapolation using empirical models in the literature (Equation 1) to obtain the wind speed at 50 m above the ground.

2.2 Modeling Components

Modeling requires a set of equations characterizing all elements of the system studied. It is therefore a crucial step for the energy models of the various components must be reliable to accurately reflect the transfer of flows between different components. This stage, the

condition which is essential is to know the wind speed, the profile of consumption and the relative data with the equipment, in order to be able to determine at every time, the power which the system of production can provide.

2.2.1 System components

The sizing system (Fig. 3) consists of wind turbines, a converter, a batteries bank, a charger and an inverter. The system is autonomous, the presence of a storage device is essential in order to satisfy, at any time, consumer demand.

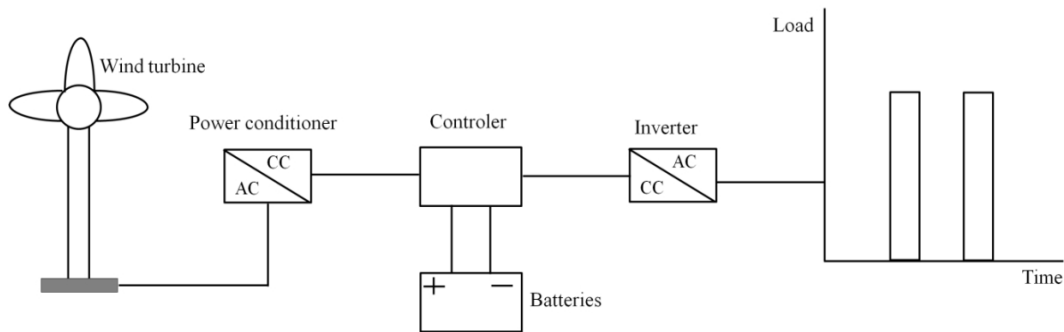

Fig. 3. Block diagram of a wind system

It is intended for the power supply of a rural household of a locality of Benin (Dekin), located at about thirty km of Cotonou, of Latitude 6°34'N and of Longitude 2°33'E. The consumption profile adopted is shown in Fig. 4. This profile is assumed to be identical for all days of the year. The annual consumption is estimated at 1.523 kWh.

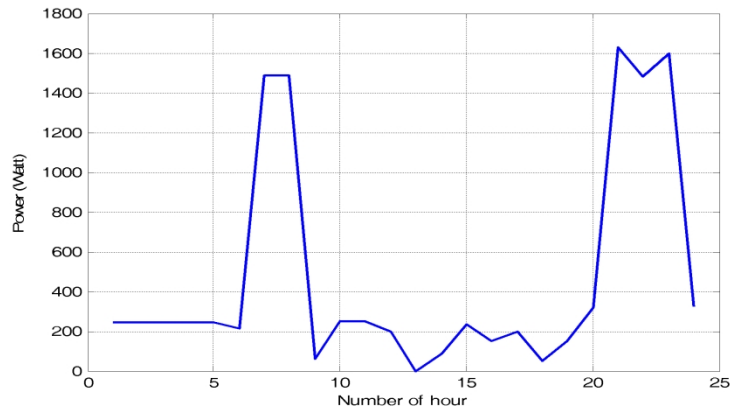

Fig. 4. Distribution of the consumer power requirements during the day

The design variables needed to determine solutions are summarized in Table 1.

Table 1. Design variables

Design variables	Nomenclature	Range	Component type considered
Wind turbine number	N_w	1 - 20	-
Battery number	N_b	1 - 15	-
Type of wind	T_w	1 - 2	600 W 1300 W
Type of battery	T_{bat}	1 - 2	75 Ah et 100 Ah
Type of tower	T_{tower}	1 - 3	50m 60m et 70m

2.2.2 Wind turbine system model

Power output of wind turbine generator at a specific site depends on wind speed at hub height and speed characteristics of the turbine. Wind speed at hub height can be calculated by using power-law equation [7]:

$$V_2 = V_1 \left(\frac{Z_2}{Z_1} \right)^\alpha \tag{1}$$

Where V_1 and V_2 are the wind speed at hub and reference height Z_1 and Z_2 and α is roughness coefficient whose value generally varies between 0.1 and 0.25 depending on the site. The one-seventh power law (0.14) is a good reference number for relatively flat surfaces such as the open terrain of grasslands away from tall trees or buildings. The power generated by the turbine is calculated as follows [8]:

$$P_w = \begin{cases} 0 & ; V_c \leq V_w, V_w \leq V_c \\ P_{w_{max}} * \left(\frac{V_w - V_c}{V_r - V_c} \right)^3 & ; V_c < V_w \leq V_r \\ P_{w_{max}} + \frac{P_f - P_{w_{max}}}{V_o - V_r} * (V_w - V_r) & ; V_r \leq V_w \leq V_o \end{cases} \tag{2}$$

Where, V_c , V_o , and V_r are the cut-in, cut-out, and rated speed of turbine (m/s), respectively. Also, $P_{w_{max}}$ is the maximum output power of the turbine (W) and P_f is the power when $V_w = V_o$. The two turbines used in this study are of IMEX-Blade using Maglev technology. Their characteristics are summarized in Table 9.

2.2.3 Model of the storage system: charging and discharging

The model developed by [9] is used; which allows to calculate the storage capacity depending on the power produced by the wind turbine and the load demand. Modeling of the battery is necessary, particularly to establish its instantaneous state of charge with a view to optimize the management of energy within the system. The state of charge of a battery at an instant t, depends on its previous state (t-1). To simplify the study, we will cover the charge efficiency and discharge in the overall performance of the battery (supplied energy / energy

consumed) we take into account the level of charge of the battery (this is ie as if the discharge performance was 100%). The energy called "battery" will be an actual energy available for charging [10]. The battery performance depends on several parameters including fluctuates with the state of charge of the battery (depending on load current) [11]. During charging, it is between 0.65 and 0.85. Although criticized, the assumption of a constant yield is considered in this study. Its value is taken as 85%. When the power produced by the wind turbine exceeds called instantaneous power, the battery is charging and capacity at time t , can be described as follows [9]:

$$E_B(t) = E_B(t-1)(1-\sigma) + \left(E_W(t) - \frac{E_L(t)}{\eta_{ond}} \right) \eta_{bat} \quad (3)$$

When the power required by the load is greater than the energy produced by the wind turbine, the battery is discharged to fill the gap, in this case, the energy stored at one moment t , can be expressed by the following relation:

$$E_B(t) = E_B(t-1)(1-\sigma) + \left(E_W(t) - \frac{E_L(t)}{\eta_{ond}} \right) \quad (4)$$

Where $E_B(t)$ and $E_B(t-1)$ are respectively the energy stored in the battery (Wh) at time t and $t-1$, σ is the time rate of self-discharge of the battery, $E_W(t)$ is the energy generated by the turbine (Wh), $E_L(t)$ is the load required (Wh), η_{ond} is the efficiency of the inverter and η_{bat} is the efficiency of the battery. The simulation step Δt is equal to $1h$.

2.2.4 Model of the inverter

The power supply of the electric charges of the consumer being carried out by alternating, an inverter is required to perform the DC-AC conversion. The inverter used and modeled (Equation 5) has a nominal output of 2.3 kVA.

$$P_{ond} = (P_W + P_{bat}) * \eta_{ond} \quad (5)$$

Where, $P_{ond}(kW)$ is the power supplied by the inverter and η_{ond} the inverter efficiency. $P_{bat}(kW)$ is the power supplied by the battery and $P_W(kW)$ is the power generated by the turbine.

The energy efficiency of an inverter is not constant as it depends on the power produced by the wind turbine. But that criticism, for the sake of simplicity, we assume in this work that this efficiency is a constant, this is an approximation.

2.3 Criteria for Evaluating System Performance

2.3.1 Economic criteria

The choice of criteria is a crucial step in the formulation of an optimization problem. Thus, the criteria necessary for the evaluation of system performance is related to aspects economic, environmental and reliability.

The randomness that characterizes the production system has required its analysis on all his life. Thus, we took into account the costs of energy and economic life cycle of the system.

2.3.1.1 The economic model based on the LCC concept

Life cycle cost (LCC) includes the cost of initial investment, the cost of replacing the component, the cost of maintenance and repair and the cost of downtime. For a component of the system i , the economic cost of the life cycle (during 25 years) can be expressed by the following equation [12]:

$$LCC_i = N_i (CI_i + CR_i \cdot K_i + CMR_i \cdot PWA(ir, R_v)) \quad (6)$$

With:

$$K_i = \sum_{n=1}^{y_i} \frac{1}{(1+ir)^{nL_i}} \quad (7)$$

$$y_i = \left(\frac{R_v}{L_i} \right) - 1 \text{ If } R_v \text{ is dividable to } L_i \quad (8)$$

$$y_i = \frac{R_v}{L_i} \text{ If } R_v \text{ is not dividable to } L_i \quad (9)$$

$$PWA(ir, R_v) = \frac{(1+ir)^{R_v} - 1}{ir(1+ir)^{R_v}} \quad (10)$$

Where N_i is number/size, CI_i is the initial investment cost, CR_i is the replacement cost, CMR_i is the cost of maintenance and repair of component i . PWA and K_i are annual and single payment present worth factors, respectively. y_i and L_i are number of replacements of component i and its life time. ir is real interest rate, R_v is project's lifetime.

During the operating time T of the system, the energy deficit $LOEE$ can be expressed by:

$$LOEE = \sum_{t=1}^T LPS(t) \cdot \Delta t \tag{11}$$

Where $LPS(t)$ is the difference between the power demand and the power output of the wind turbine and the battery at a time t .

The cost relating to the unavailability of the system during the time of simulation T can be expressed by [13]

$$LCC_{loss} = LOEE \cdot C_{loss} \cdot PWA(ir, R_v) \tag{12}$$

Where C_{loss} is the equivalent cost of load curtailment per kWh (\$/ kWh).

We then deduce the total economic cost of the life cycle of the system:

$$C_{total} = \sum_i LCC_i + LCC_{loss} \tag{13}$$

In this study, we chose $ir = 6\%$ and $R_v = 25 \text{ years}$. The economic costs of the different components of the system are summarized in Table 2.

Table 2. Components specifications ([14], [12])

Component	CI	CR	CMR	Efficiency (%)	Life (yr)
Wind turbine	2 US\$/W	2 US\$/W	0,02 US\$/W/yr	-	25
Battery	0,5 US\$/Wh	0,5 US\$/Wh	9 US\$/Wh/yr	85	4
Inverter	0,7 US\$/VA	0,7 US\$/VA	37 US\$/yr	90	15
Tower	250 US\$/m	250 US\$/m	6,5 US\$/m/yr	-	25

2.3.1.2 Cost of loss of load

This cost includes all the economic consequences induced by a stop of a component or system. In our study, this cost is taken equal to 5.6 US\$/kWh [15].

2.3.2 Reliability criteria

Because of the intermittent wind speed characteristics, which highly influence the energy production from the system, power reliability analysis is usually considered as an important step in any such system design process. There are a number of methods used to calculate the reliability of the systems. The most popular method is the loss of power supply probability (LPSP) method. The LPSP is the probability that an insufficient power supply results when the system (wind power and energy storage) is not able to satisfy the load demand. The design of a reliable stand-alone wind system can be pursued by using the LPSP as the key design parameter. For an analysis period T, the LPSP is the ratio of the sum of all values of energy loss LPS for the same period of the energy required.

The loss of energy A is expressed by [9]:

$$LPS(t) = E_L(t) - (E_W(t) + E_B(t-1) - E_{B,\min}) \eta_{ond} \quad (14)$$

LPS is expressed by:

$$LPSP = \frac{\sum_{t=1}^T LPS(t)}{\sum_{t=1}^T E_L(t)} \quad (15)$$

Where $E_{B,\min}$ is the minimum charge quantity of battery bank.

2.3.3 Environmental criteria

2.3.3.1 Gross energy requirement

The life cycle analysis is a tool for decision support in eco-design for evaluating the environmental impact of the system, from raw material extraction to end of life system. The indicator chosen in this study is the Gross energy requirement (GER). This cost represents the total primary energy required for the manufacture, maintenance, recycling and transport to the place of use of the system. For an autonomous wind system, the overall energy cost is as follows:

$$GER_{Total} = N_W \cdot P_n \cdot GER_W \cdot DV_W + N_b \cdot C_{b,n} \cdot GER_{bat} \cdot y_b \cdot DV_{bat} + P_{n,inv} \cdot GER_{inv} \cdot y_{inv} \cdot DV_{inv} + GER_{tower} * H \quad (16)$$

Where GER_{Total} is primary energy cost of the system. GER_W is primary energy cost, P_r is rated power, DV_W is the life, of the wind. GER_{bat} is primary energy cost, DV_{bat} is the life, y_b is number of replacements, of the battery. GER_{inv} is primary energy cost, DV_{inv} is the life, y_{inv} is number of replacements, of the inverter. GER_{tower} and H are primary energy cost and height of the mast, of the wind, respectively.

2.3.3.2 Life cycle CO₂ emissions

Energy consumption during the implementation of the system generates CO₂ emissions can also be evaluated as follows:

$$GES_{Total} = N_W \cdot P_r \cdot GES_W \cdot DV_W + N_b \cdot C_{b,n} \cdot GES_{bat} \cdot y_b \cdot DV_{bat} + P_{n,inv} \cdot GES_{inv} \cdot y_{inv} \cdot DV_{inv} + GES_{tower} * H \quad (17)$$

Where GES_{Total} is total CO₂ emissions of system, GES_W is CO₂ emission from wind, GES_{bat} is CO₂ emission from battery, GES_{inv} is CO₂ emission from inverter, GES_{tower} is CO₂ emission from tower.

Table 3 shows the calculation results for the energy consumption and CO₂ emissions during system equipment manufacture. These are the numerical values per unit capacity per year.

Table 3. Energy consumption and CO₂ emissions in the system equipment manufacturing ([16], [17])

Components	Facility energy	CO ₂ emissions
Wind turbine	0,215 kWh/W.yr	69 g CO ₂ /W.yr
Battery	0,207 kWh/Wh.yr	62 g CO ₂ /Wh.yr
Inverter	0,4 kWh/VA.yr	12,5 g CO ₂ /VA.yr
Tower	7,2 kWh/m	5,9 g CO ₂ /m

2.4 Models of the Rates of Satisfaction

The different criteria used in this study are not the same size. To solve this problem of scaling, desirability functions for transforming the variables dimensionless criteria are tapped. But the choice of a desirability function depends on the requirements of the study to be conducted in our case, all criteria are to minimize as shown in Table 6. For this purpose, the function of desirability of Harrington is used [18]:

$$d(Y_m) = \exp(-\exp(\beta + \alpha.Y_m)) \tag{18}$$

With

$$\alpha = \frac{\ln(\ln(0.01)/\ln(0.99))}{AUC - USL}, \beta = \ln(-\ln(0.99)) - \alpha.USL$$

Where *d* is the desirability associated with the criterion *Y_m*, *AUC* is the absolute upper cutoff, *USL* is the upper soft limit for the criterion. Levels of criteria are summarized in Table 4.

Table 4. Levels of criteria [19]

Criteria	Aim	USL	AUC
CI	Minimize	100	70000
CR	Minimize	100	70000
CMR	Minimize	20	600
LCC _{loss}	Minimize	0	10 ⁵
LPSP	Minimize	0	60 %
GER	Minimize	49663	2.10 ⁵
GES	Minimize	1049968	3.10 ⁷

Then, the criteria are aggregated according the aggregation method based on weighted geometric mean of the functions of desirabilities [20]:

$$DOI_k = \prod_{r=1}^q d_r^{v_r} \tag{19}$$

Where DOI_k denote the indices of desirability and v_r the weights relating to the criteria. DOI_1 is the index relating to the economic shutter, DOI_2 is related to the reliability of the system, DOI_3 is related to the environmental aspects.

Desirability indices obtained are aggregated according the same principle to lead to the global objective function:

$$OF = \prod_{k=1}^3 DOI_k^{w_k} \tag{20}$$

Where w_k denote the weighting coefficients concerning index of desirability.

The weights used are essential because they represent the wishes of the user in the implementation of the wind system. The values of these weights are summarized in Tables 5, 6 and 7.

Table 5. Weight of the indices of desirabilities

	DOI₁	DOI₂	DOI₃
Weight (%)	22.55	67.38	10.07

Table 6. Weight-related criteria DOI₁

Criteria	CI	CR	CMR	LCC_{loss}
Weight (%)	52.24	24.93	13.4	6.79

Table 7. Weight-related criteria DOI₃

Criteria	GER	GES
Weight (%)	62.67	37.33

2.5 Optimization Method Used

The optimization of the dimensioning of wind turbine system is a multi-objective optimization. Indeed, the cost of the system (whether economic or energy) should be minimal while providing consumers with quality electricity supply the best possible. The number of variables is important, our choice fell on a genetic algorithm called NSGA-II (« Nondominated Sorting Genetic Algorithm II ») [21]. This algorithm is called evolutionary since it refers to the theory of biological evolution. It is a multi-objective algorithm under constraints, based on a comprehensive approach to optimization in the sense that the exploratory nature of the algorithm will allow us to get the optimum sweeping wide spectrum of possibilities offered by the range of variation of the design variables. The main parameters of this algorithm are:

- ✓ Number of generations $N_G = 50$
- ✓ Number of individuals per generation $N_{ind} = 100$
- ✓ Design variables (Table 1)

- ✓ Probability of crossover $P_c = 0,80$
- ✓ Mutation probability $P_m = 0,05$

The algorithm used to evaluate the performance of each individual by calculating the objectives, constraints specific to this individual and the global objective function after taking into account all the steps of the algorithm (crossover and mutation).

In this study, seven criteria are considered. These are:

- Minimization of all criteria under DOI_1 (CI, CR, CMR, LCC_{loss}) ;
- Minimization of the criterion under DOI_2 (LPSP) ;
- Minimization of all criteria under DOI_3 (GER, GES).

After modeling the problem in our approach to optimize multi-objective can be summarized as follows:

$$\begin{aligned}
 & \text{Find } x = [N_w, N_b, T_w, T_{bat}, T_{tower}]^T \\
 & \text{Which minimizes } OF(x) = \{CI(x), CR(x), \dots, GES(x)\} \\
 & \text{Subject to } 100 \leq CI(x) \leq 70000 \\
 & \quad 100 \leq CR(x) \leq 70000 \\
 & \quad \dots\dots\dots \\
 & \quad 1049968 \leq GES(x) \leq 3.10^7 \tag{21} \\
 & \quad 1 \leq N_w \leq 20 \\
 & \quad 1 \leq N_b \leq 15 \\
 & \quad 1 \leq T_w, T_{bat} \leq 2 \\
 & \quad 1 \leq T_{tower} \leq 3
 \end{aligned}$$

Thus, for different sets of combination of design variables, the corresponding global objective functions are determined. The candidate solutions obtained are ranked in descending order according to their corresponding satisfaction.

3. RESULTS AND DISCUSSION

Desirability indices related respectively to economic criteria and system reliability are shown in Fig. 5. We note that the maximum DOI_1 is 0.964 and the associated optimal configuration corresponds to 14 wind turbines of 600 W, 3 batteries of 75 Ah with a mast height of 50 m is a ratio of 0.43 Wh / W. Whereas the maximum DOI_2 is 0.9857 and the optimal configuration is associated with a 600 W, 7 batteries 100 Ah, with a mast 60 m, a ratio of 14 Wh / W. A similar representation is made in Fig. 10. The maximum value DOI_3 is 0.9886 and the associated optimal configuration is 9 wind turbines of 600 W, 7 batteries of 100 Ah with a mast 50 m, a ratio of 1.56 Wh/W. Obviously, the three indices of desirability not lead to the same optimal configuration. Thus, the global objective function after aggregation index of desirability and shown in Fig. 6 has the maximum value 0.8284.

The results presented in Figs. 5 and 6 are those obtained in the last generation, which is also our stopping criterion.

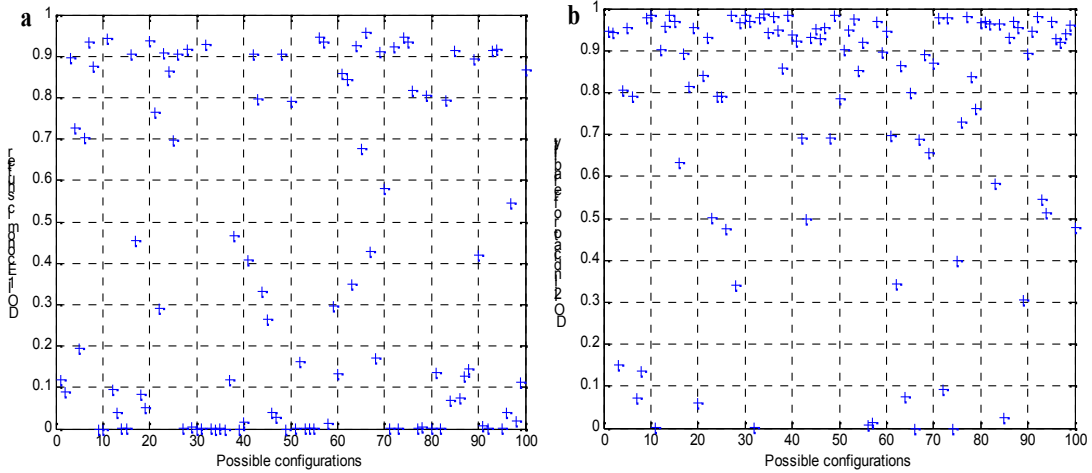

Fig. 5. Evolution of the objective functions based on combinations of design variables: (a) Desirability index related to the economic shutter. (b) Desirability index related to the reliability of the system

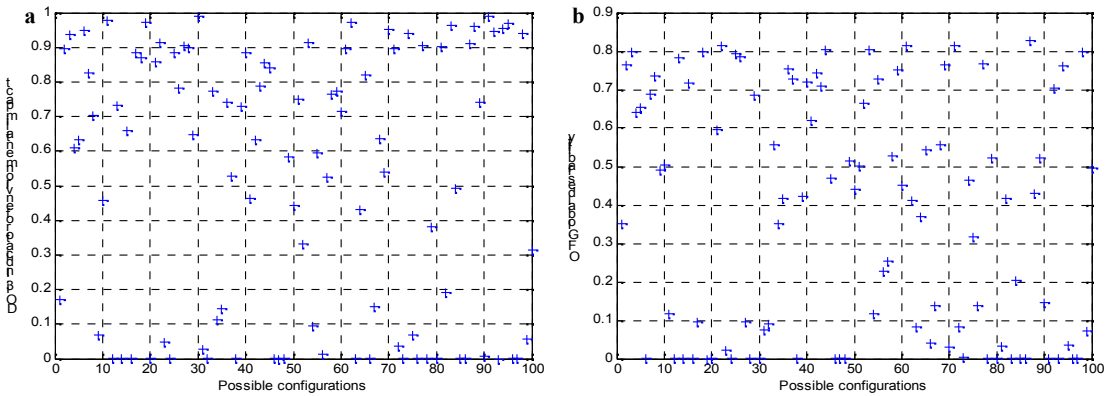

Fig. 6. Evolution of the objective functions based on combinations of design variables: (a) Desirability index linked to environmental aspects. (b) Global objective function of the system

Fig. 7 is a 3D representation of the loss power supply probability and initial investment costs for various combinations of wind turbines and batteries with types of wind turbines, batteries and masts fixed.

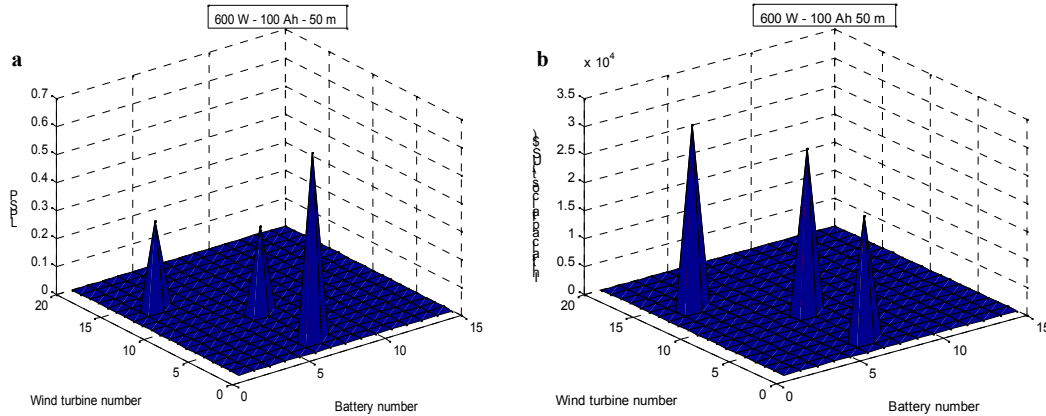
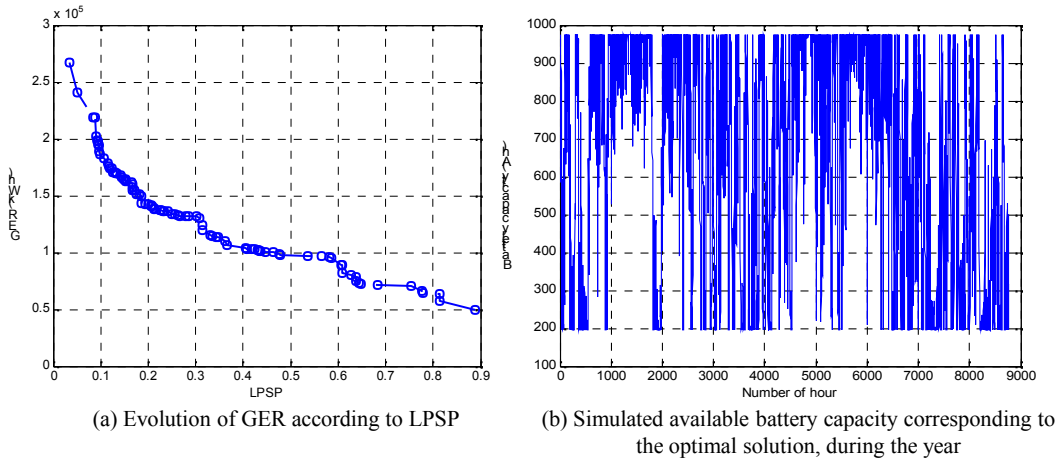

Fig. 7. 3D for various combinations of wind turbines and batteries for different values of LPSP and CI

Fig. 8 (a), it is possible to observe all the solutions in the plane defined by two such criteria are minimized. Logically, the criteria are contradictory, more the consumer tolerates an important LPSP, the greater the wind system may be undersized and therefore cheaper on the whole of his life. For example, the fact of tolerating an unballasting of only of 10% of the energy called by the consumer makes it possible to reduce the GER of 67%. The explanation is that the system is dimensioned to operate in the harshest conditions that may occur on the time of use, accept a low LPSP relieves the system corresponding period. The system can then be undersized. The results presented in Fig. 8 are those obtained in the last generation.



(a) Evolution of GER according to LPSP

(b) Simulated available battery capacity corresponding to the optimal solution, during the year

Fig. 8. Sizing results for consumption profile characteristic

Table 8. Characteristics of the ten best solutions

N°	N_w	N_b	T_w	T_{bat}	T_{tower}	CI	CR	CMR	LCC_{loss}	GER	GES	LPSP	OF
1	9	7	1	2	50	20358	20358	471	238	50190	2253783	0,8011	0,8228
2	14	3	1	2	50	17816	17816	413	232	51470	2081512	0,7809	0,8152
3	14	4	1	1	50	23816	23816	511	167	71270	4153587	0,5631	0,8147
4	13	3	1	2	60	22103	22103	502	261	84350	1052043	0,8789	0,8138
5	8	10	1	1	70	23560	23560	479	141	75750	6223240	0,4752	0,8041
6	5	8	2	2	50	25004	25004	542	181	81820	4500027	0,6077	0,8027
7	5	10	2	1	50	22003	22003	461	198	90720	3121984	0,6664	0,7991
8	9	7	1	1	50	26274	26274	541	140	89660	5190891	0,4702	0,7985
9	11	4	1	1	70	30704	30704	639	104	90500	7260086	0,3497	0,7890
10	5	13	2	1	60	22792	22792	497	198	100200	3123424	0,6659	0,7848

The characteristics of the ten best solutions are summarized in Table 8. These solutions are obtained as a result of classification according to the descending values of the global objective function. The objective functions represent the desires and wishes of the designer. This table implements solutions to promote shedding solutions and ensuring continuous coverage of consumer needs. In addition, the battery bank corresponding to the tenth solution has a total nominal capacity of 975 Ah and variation of available capacity during the year is shown in Fig. 8 (b).

4. CONCLUSION

In this paper, we described the definition of criteria for evaluating the performance of a wind system autonomy over its life cycle. These criteria were used for the simulation in the context of optimizing the design of the system. To carry out these studies, a methodology for analysis and multi-objective optimization based on conflicting criteria: cost (economic or energy) of the life cycle and other quality of service associated with shedding consumption. The aim of the proposed methodology is to determine from a list of components available on the market, the optimal number of wind turbines, batteries and the optimal type of wind turbines, batteries and mast. For each combination of sets of design variables is calculated the minimum cost (economic and energy) of the system life cycle while ensuring uninterrupted coverage of consumer needs. Different objective functions used in this study are aggregated through weight defining the consumer wishes to obtain the global objective function. The method of genetic algorithm was used to generate candidate solutions which are ranked in descending order according to their corresponding objective function. The proposed method has been applied to the design of a wind turbine system for the production of electrical energy to a rural household.

Moreover, when multiple wind turbines are installed in the same place, the shadow effect becomes very important. It would be interesting to conduct further studies to determine the optimal positioning of wind turbines.

COMPETING INTERESTS

Authors have declared that no competing interests exist.

REFERENCES

1. Maldague M. Politique énergétique intégrée en République Démocratique du Congo. Leçon publique donnée le 6 octobre 2001 à l'occasion de l'inauguration solennelle de l'Académie.
2. Rühl C. BP Statical review of world energy 2010. Bp.com/statisticalreview.
3. Yang H, Zhou W, Lin Lu, Fang Z. Optimal sizing method for stand-alone hybrid solar-wind system with LPSP technology by using genetic algorithm. *Solar Energy*. 2008;82:354-367.
4. Dufo-López R, Bernal-Agustín JL. Multi-objective design of PV-wind-diesel-hydrogen-battery systems. *Renewable Energy*. 2008;33:2559-2572.
5. Dufo-López R, Bernal-Agustín JL, Yusta-Loyo JM, Domínguez-Navarro JA, Ramírez-Rosado IJ, Lujano J, Aso I. Multi-objective optimization minimizing cost and life cycle emissions of stand-alone PV-wind-diesel systems with batteries storage. *Applied Energy*. 2011;88:4033-4041.

6. Bernal-Agustín JL, Dufo-López R, Rivas-Ascaso DM. Design of isolated hybrid systems minimizing costs and pollutant emissions. *Renew Energy* 2006;31(14):2227–44.
7. Patel MR. *Wind and solar power systems*. UK: CRC Press; 1999.
8. Mallikarjuna R, Joydeep M. Siting and Sizing of Distributed Generation for Optimal Microgrid Architecture, 2006. *IEEE Trans Power System*. may 2006;20(2)647-655.
9. Bogdan BS, Salameh ZM. Methodology for optimally sizing the combination of a battery bank and PV array in a wind/PV hybrid system. *IEEE Transactions on Energy Conversion*. 1996;11:367–375.
10. Shen WX. Optimally sizing of solar array and battery in a stand-alone photovoltaic system in Malaysia. *Renewable energy*. 2009;34:348-352.
11. Boitier A, Alonso C. Dimensionnement d'un système photovoltaïque. CETSIS'2005, Nancy, 25-27 october 2005.
12. Navaeefard A, Moghaddas Tafreshi SM, Mehdi Derafshian Maram. Distributed energy resources capacity determination of a hybrid power system in electricity market. 25th International Power System Conference. 2010;10-E-EPM-2163, PSC.
13. Kassmi K. Conception et modélisation d'un système photovoltaïque adapté à une commande MPPT analogique. *Revue des Energies Renouvelables*. 2007;N°4:451-462.
14. Thiaux Yaël. Optimisation des profils de consommation pour minimiser les coûts économique et énergétique sur cycle de vie des systèmes photovoltaïques autonomes et hybrides. Evaluation du potentiel de la technologie Li-ion. Thèse de doctorat, Ecole Nationale Supérieure de Cachan ; 2010.
15. Garcia RS, Weisser D. A wind-diesel system with hydrogen storage: Joint optimization of design and dispatch. *Renewable Energy*. 2006;31:2296-2320.
16. Kemmoku Y. Life cycle CO₂ emissions of a photovoltaic, wind/diesel generating system. *Electrical engineering in Japan*. 2002;138:N° 2.
17. Alsema EA, de Wild-Scholten MJ. Environmental impact of crystalline silicon photovoltaic module production. Presented at 13th CIRP Intern. Conf. on Life cycle engineering, Leuven, 31 may-2 June; 2006.
18. Sebastian P, Quirante T, Ho Kon Tiat V, Ledoux Y. Multi-objective optimization of the design of two-stage flash evaporators: Part 2. Multi-objective optimization. *International Journal of Thermal Sciences*. 2010;49:2459-2466.
19. Bobée J. L'électrification rurale pour l'énergie solaire. Etude de cas au Bénin. Master en Sciences de la Population et du Développement. 2010; Université Libre de Bruxelles.
20. Derringer G, et al. Simultaneous optimization of several response variables. *JQT*, tome 12; 1980.
21. Deb K, Pratap A, Agarwal S, Meyarivan T. A fast and elitist multi-objective Genetic algorithm: NSGA-II. *IEEE Transaction on Evolutionary Computation*. 2002;6(n.2):182–197.

ANNEX

Characteristics of the two turbines and two batteries

Table 9. Characteristics of the two wind turbine

Characteristics	Wind turbine 1	Wind turbine 2
P_{Wmax}	600 W	1300 W
Diameter	1.06 m	2 m
height	1.20 m	2.1 m
V_c	1 m/s	1 m/s
V_r	12 m/s	13 m/s
V_o	65 m/s	60 m/s
P_f	580 W	1200 W

Batteries of 75 Ah and 100 Ah (only nominal capacity of two different)

$$U_{b,n} = 12 V ; \sigma = 0.00004 ; DOD = 85\% ; \eta_{bat} = 85\%$$

© 2013 Semassou et al.; This is an Open Access article distributed under the terms of the Creative Commons Attribution License (<http://creativecommons.org/licenses/by/3.0>), which permits unrestricted use, distribution, and reproduction in any medium, provided the original work is properly cited.

Peer-review history:

The peer review history for this paper can be accessed here:
<http://www.sciencedomain.org/review-history.php?iid=224&id=4&aid=1492>